

BACK

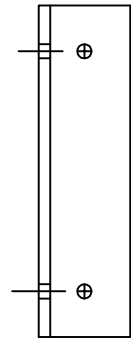

MOUNTING BRACKET CAN BE REPOSITIONED FOR VERTICAL MOUNTING

FRONT

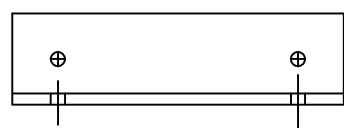
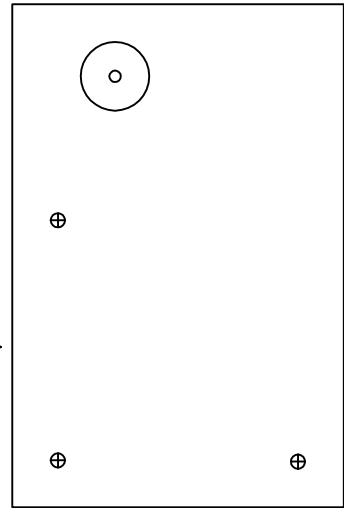
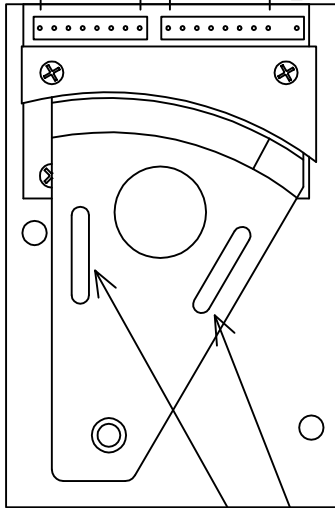

BALL JOINT LINKAGE CAN BE INSTALLED IN EITHER SLOT AND ADJUSTED AS REQUIRED FOR CORRECT TRAVEL.

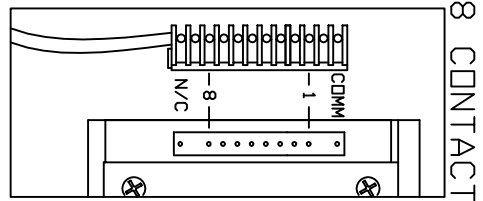

16 CONTACT

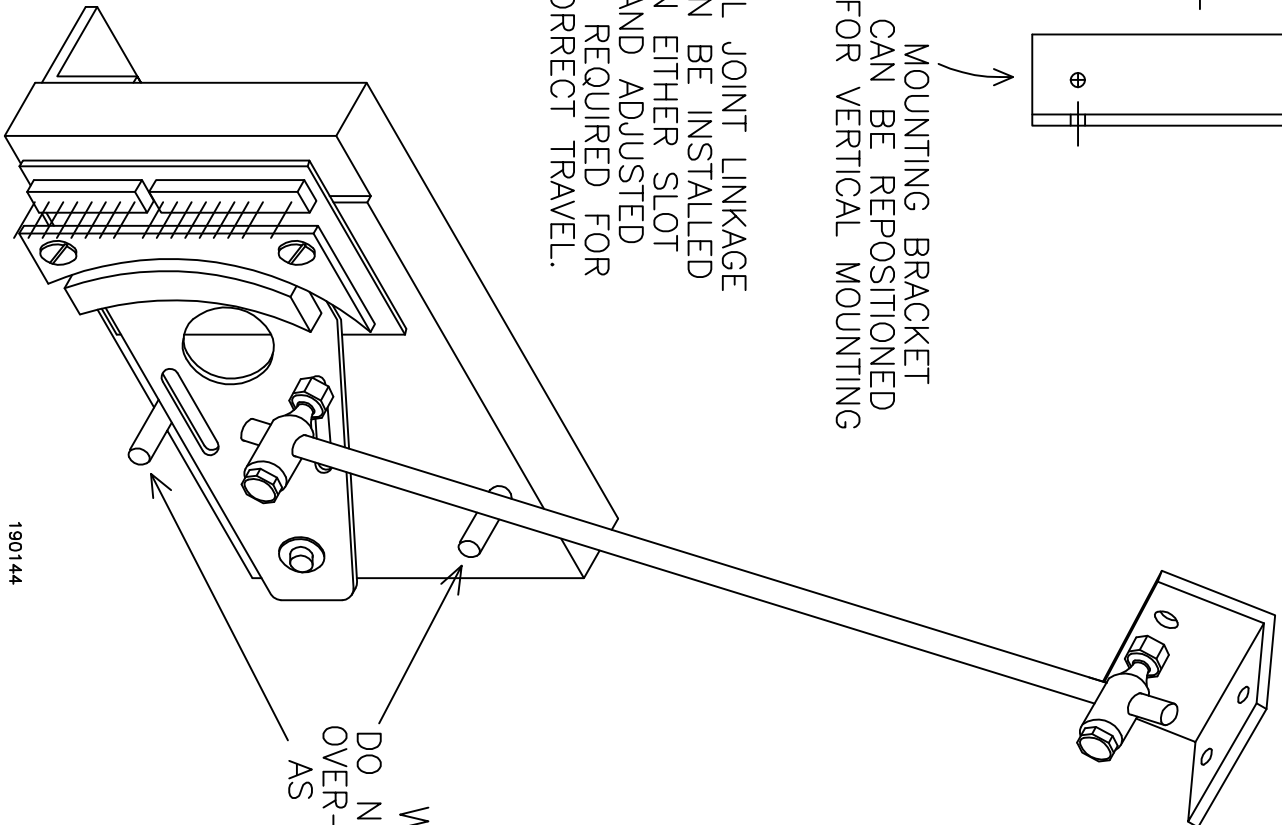
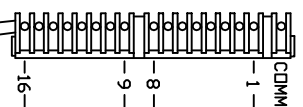

WARNING!
DO NOT USE THESE OVER-TRAVEL STOPS AS SHOE STOPS!